





NACELLE VERTICALE ELECTRIQUE 8 M



TOUCAN 800

CACES requis 3B-R386

- 
Hauteur de travail
8 m
- 
Charge Maxi
200 kg
- 
Déport
2.30 m
- 
Poids du matériel
1.95 t



CARACTÉRISTIQUES

| | |
|---------------------------|-----------------------|
| Constructeur | GROVE |
| Modèle | TOUCAN 800 |
| Energie | Batterie - Electrique |
| Dimensions (L x l x h) | 1.90 x 0.99 x 1.99 m |
| Dimensions Panier (L x l) | 0.65 x 0.75 m |
| Nombre de personnes | 2 |

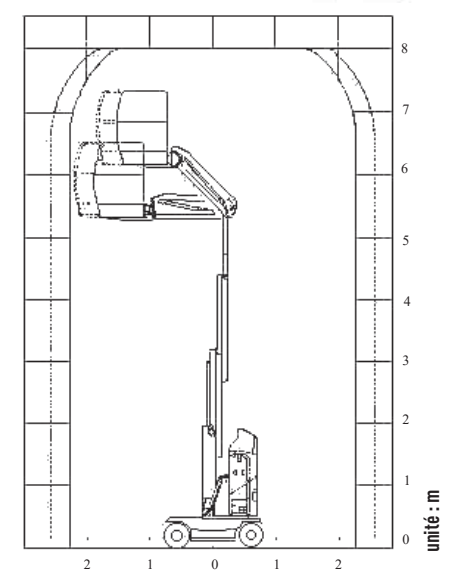
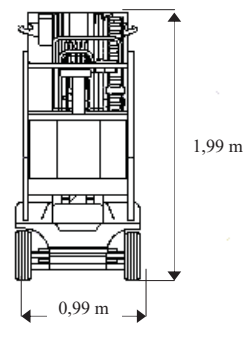
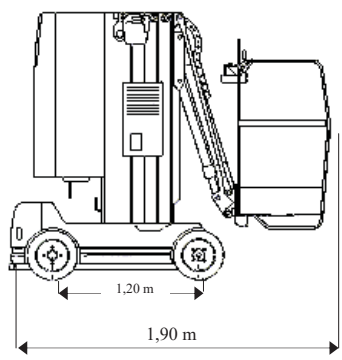
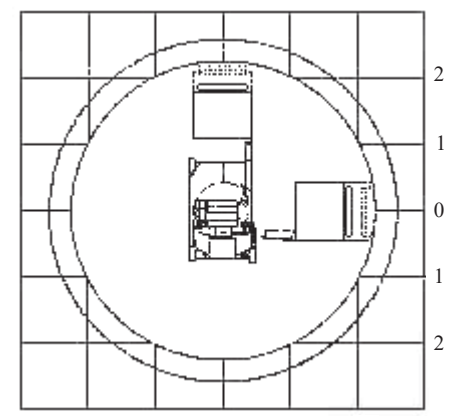

Document non contractuel