





MT 732

CACES requis 9 - R372

- 
Hauteur de levage maxi
6.90 m
- 
Capacité de levage max
3.20 t
- 
Portée maxi
4.16 m
- 
Poids du matériel
7.25 t



CARACTÉRISTIQUES

Marque	MANITOU
Modèle	MT 732
Moteur	PERKINS 1004.42
Motricité	4 Roues motrices 4 roue directrices
Vitesse	34.3 km/h
Capacité du réservoir	120 L
Dimensions (L x l x h)	4.71 x 2.26 x 2.55 m
Rayon de braquage int / ext	12.05 x 47.70 m
Garde au Sol	41 cm
Charge de basculement	1.25 t
Effort d'arrachement	5200 daN
Dimensions Fourches (L x l x e)	1.2 x 0.12 x 0.04 m
Niveau Sonore à 1m LwA	83.6 dB
Inclinaison des Fourches	113.7° / 11.9°

unité : mm

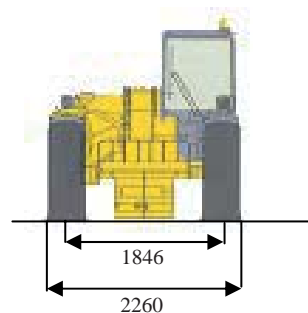
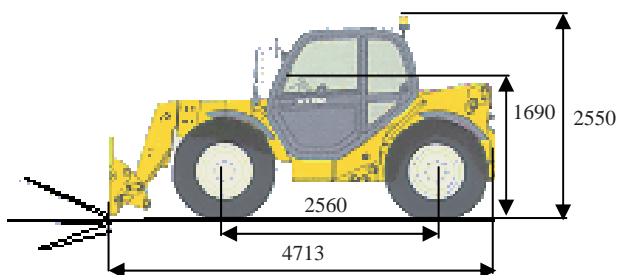

MT 732

ABAQUES

Portée à hauteur maxi : 1,15 m

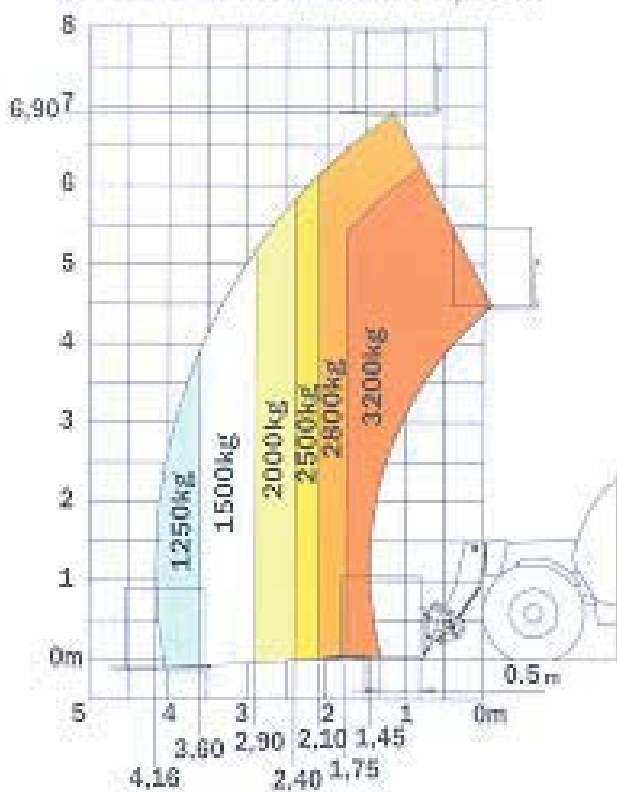

unité : m