





MT 1337 SL

CACES requis 9 - R372

- 
Hauteur de levage maxi
12.55 m
- 
Capacité de levage max
3.7 t
- 
Portée maxi
7.75 m
- 
Poids du matériel
10.80 t



CARACTÉRISTIQUES

Marque	MANITOU
Modèle	MT 1337 SL
Moteur	PERKINS 1004.4 Turbo
Motricité	4 Roues motrices 4 roue directrices
Vitesse	25 km/h
Capacité du réservoir	135 L
Dimensions (L x l x h)	5.96 x 2.42 x 2.75 m
Rayon de braquage int / ext	36.60 / 0.4 cm
Garde au Sol	41 cm
Charge de basculement	10.3 t
Dimensions Fourches (L x l x e)	1.20 x 0.12 x 0.05 m
Niveau Sonore à 1m LwA	81.5 dB
Inclinaison des Fourches	+11.87° / -112.5°

unité : mm

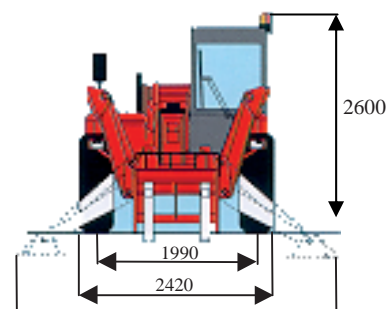
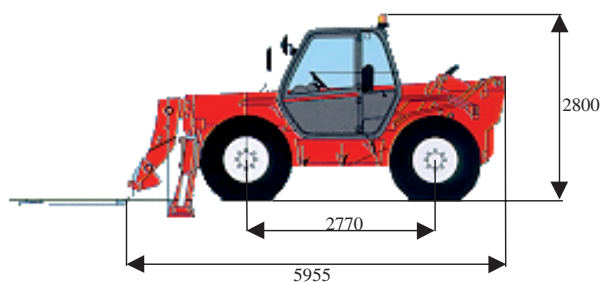

MT 1337 SL

ABAQUES

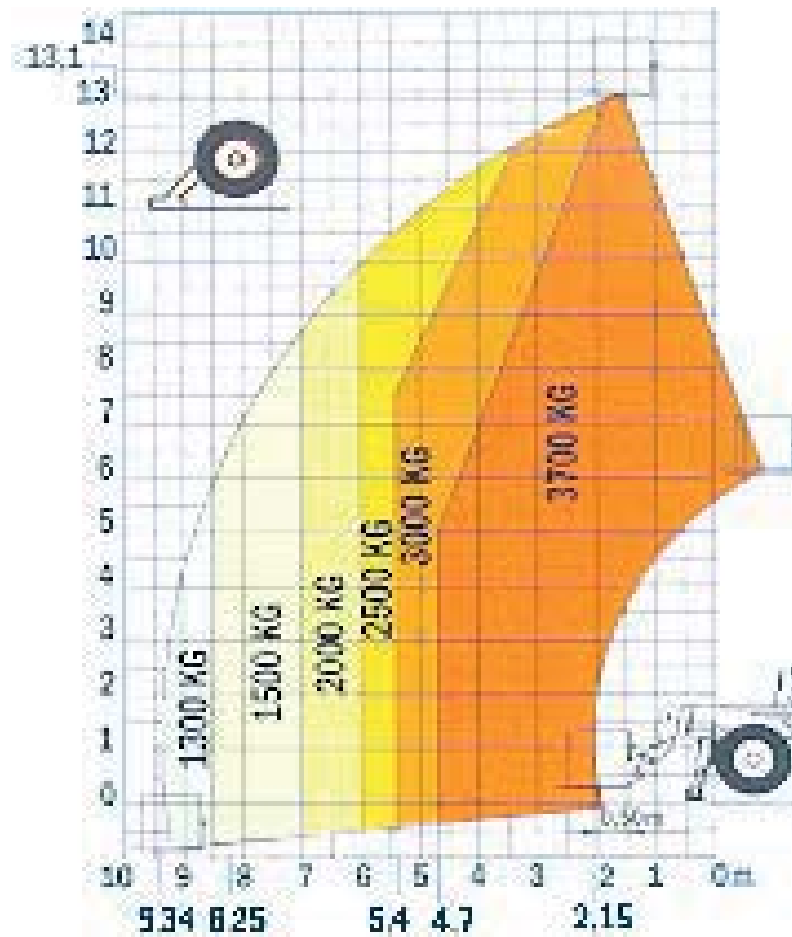

unité : m